

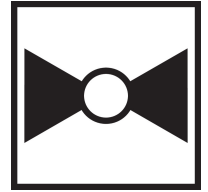

5-year warranty



Technical data

Functional data	Valve Size	4" [100]
	Fluid	chilled or hot water, up to 60% glycol
	Fluid Temp Range (water)	0...250°F [-18...120°C]
	Body Pressure Rating	ANSI Class 250, raised-face
	Close-off pressure Δps	310 psi
	Flow characteristic	equal percentage
	Servicing	maintenance-free
	Maximum differential pressure (water)	50 psi [345 kPa]
	Flow Pattern	2-way
	Leakage rate	0% for A – AB
	Controllable flow range	75°
	Cv	186
	Cv Flow Rating	A-port: as stated in chart B-port: 70% of A – AB Cv
	Materials	Valve body
Spindle		stainless steel
Spindle seal		EPDM (lubricated)
Seat		PTFE
Characterizing disc		stainless steel
Pipe connection		250 lb flanged
O-ring		EPDM (lubricated)
Ball		stainless steel
Suitable actuators	Non-Spring	GRB(X)
	Electrical fail-safe	GKRB(X)

Safety notes



- WARNING: This product can expose you to lead which is known to the State of California to cause cancer and reproductive harm. For more information go to www.p65warnings.ca.gov

Product features

Application This valve is typically used in air handling units on heating or cooling coils, and fan coil unit heating or cooling coils. Some other common applications include Unit Ventilators, VAV box re-heat coils and bypass loops. This valve is suitable for use in a hydronic system with variable flow.

Flow/Mounting details

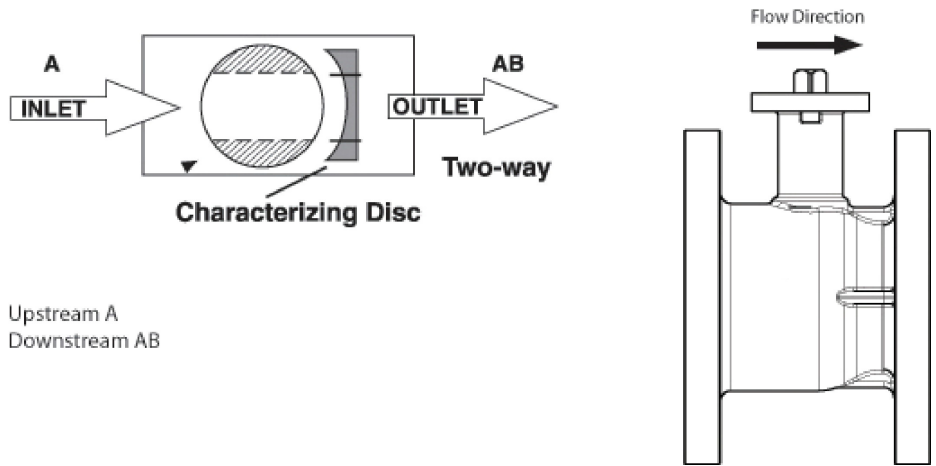

Dimensions

Dimensional drawings

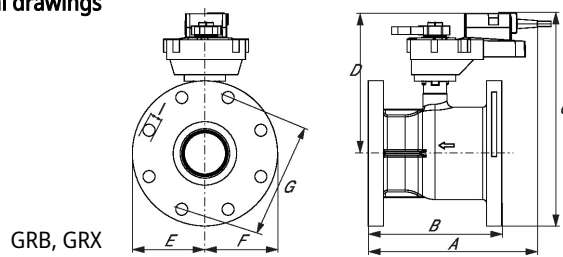

Type

DN

Weight [kg]
[kg]

B6400S-186-250

100

23

A	B	C	D	E	F	G	I	Number of Bolt Holes
11.3"	[286]8.3"	[210]12.8"	[325]8.7"	[221]4.4"	[113]4.4"	[113]7.9"	[200]0.9"	[22] 8

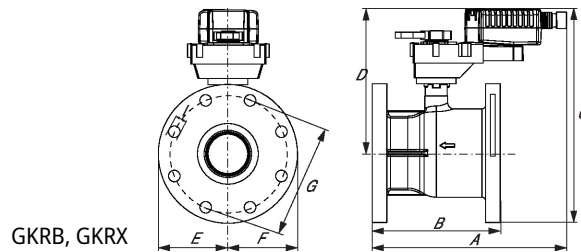

A	B	C	D	E	F	G	I	Number of Bolt Holes
11.3"	[286]8.3"	[210]12.9"	[328]9.7"	[246]4.4"	[113]4.4"	[113]7.9"	[200]0.9"	[22] 8

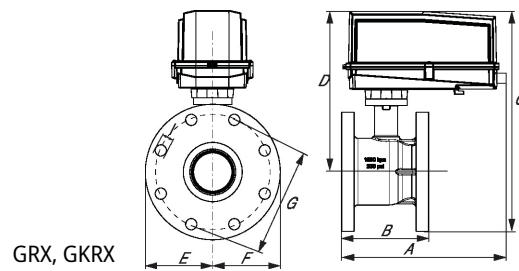

A	B	C	D	E	F	G	I	Number of Bolt Holes
15.0"	[381]8.3"	[210]16.3"	[415]12.6"	[321]4.4"	[113]4.4"	[113]7.9"	[200]0.9"	[22] 8

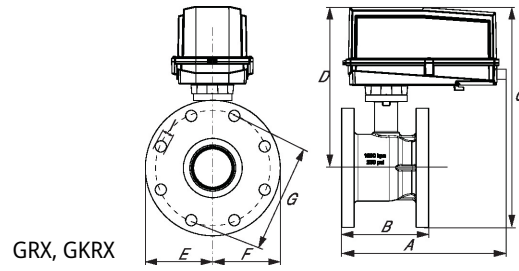

GRX, GKRX

A	B	C	D	E	F	G	I	Number of Bolt Holes								
15.0"	[381]	8.3"	[210]	16.3"	[415]	12.6"	[321]	4.4"	[113]	4.4"	[113]	7.9"	[200]	0.9"	[22]	8



5-year warranty



Technical data

Electrical data	Nominal voltage	AC 24 V
	Nominal voltage frequency	50/60 Hz
	Power consumption in operation	12 W
	Power consumption in rest position	3 W
	Transformer sizing	21 VA (class 2 power source)
	Electrical Connection	18 GA appliance cables, 3 ft [1 m], 10 ft [3 m] or 16ft [5 m], with 1/2" conduit connector
	Overload Protection	electronic throughout 0...95° rotation
Functional data	Bridging time	2 s delay before fail-safe activates
	Pre-charging time	5...20 s
	Direction of motion motor	selectable with switch 0/1
	Direction of motion fail-safe	reversible with switch
	Manual override	external push button
	Angle of rotation	Max. 95°, adjustable with mechanical stop
	Angle of rotation note	adjustable with mechanical stop
	Running Time (Motor)	150 s constant, independent of load
	Running time motor note	constant, independent of load
	Running time motor variable	90 or 150 s
	Running time fail-safe	<35 s
	Noise level, motor	52 dB(A)
	Noise level, fail-safe	61 dB(A)
Position indication	Mechanically, pluggable	
Safety data	Degree of protection IEC/EN	IP54
	Degree of protection NEMA/UL	NEMA 2
	Enclosure	UL Enclosure Type 2
	Agency Listing	cULus acc. to UL60730-1A/-2-14, CAN/CSA E60730-1:02, CE acc. to 2014/30/EU and 2014/35/EU; Listed to UL 2043 - suitable for use in air plenums per Section 300.22(c) of the NEC and Section 602.2 of the IMC
	Quality Standard	ISO 9001
	Ambient temperature	-40...176°F [-40...80°C]
	Storage temperature	-22...122°F [-30...50°C]
	Ambient humidity	Max. 95% RH, non-condensing
	Servicing	maintenance-free
	Weight	Weight

Electrical installation

INSTALLATION NOTES

- Provide overload protection and disconnect as required.
- Actuators may be connected in parallel. Power consumption and input impedance must be observed.
- Actuators may be connected in parallel if not mechanically linked. Power consumption and input impedance must be observed.
- Meets cULus requirements without the need of an electrical ground connection.
- Warning! Live electrical components!**
During installation, testing, servicing and troubleshooting of this product, it may be necessary to work with live electrical components. Have a qualified licensed electrician or other individual who has been properly trained in handling live electrical components perform these tasks. Failure to follow all electrical safety precautions when exposed to live electrical components could result in death or serious injury.

Wiring diagrams

On/Off

24 VAC Transformer (AC Only)

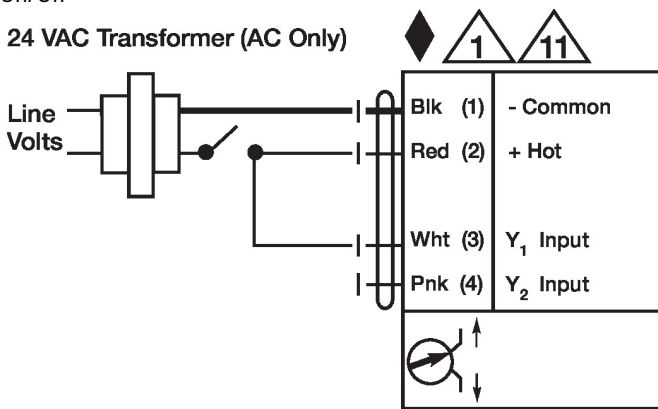

Floating Point

24 VAC Transformer (AC Only)

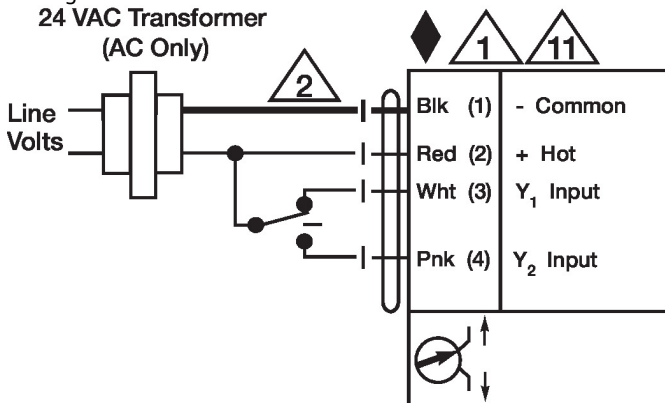

Dimensions